

1 MÍNIMO ANCHO PUERTAS Y POSICIÓN PINZAS / Minimum panels width and clamp position

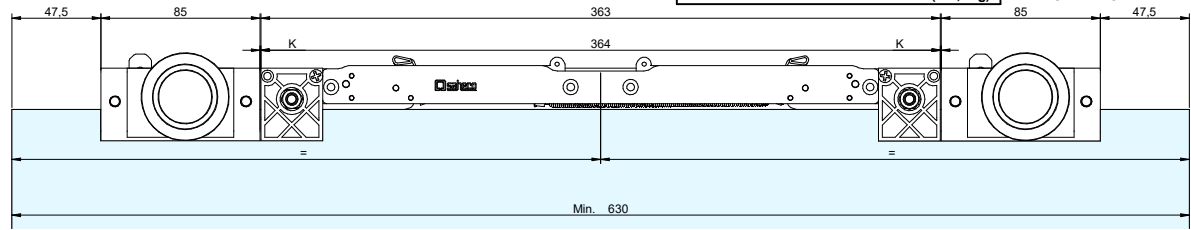

FUERZA ABRIR - Force Open = 30±2N (3±0,2 Kg)
FUERZA CERRAR - Force Close = 30±2N(30±2Kg)

RELACIÓN ALTO-ANCHO DEL VIDRIO: 3-1
High-wide glass ratio: 3-1

f

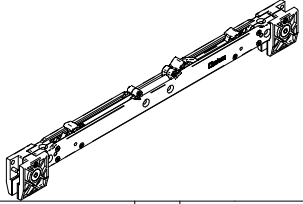

j



h



g¹



g²

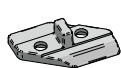

g³

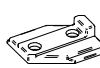

NEGRO / Black

GRIS / Gray

BLANCO / White

2 COLOCACIÓN SOFTBRAKE / Softbrake installation

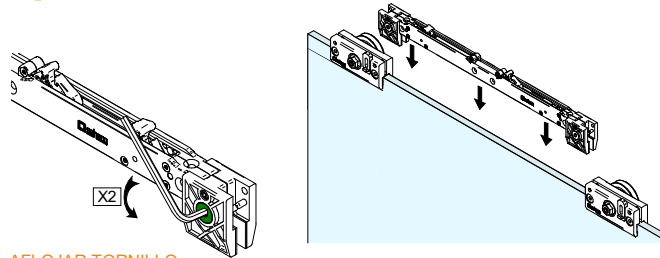

AFLOJAR TORNILLO
loosen the screw

3 AJUSTAR LOS TORNILLOS / Adjust the screws

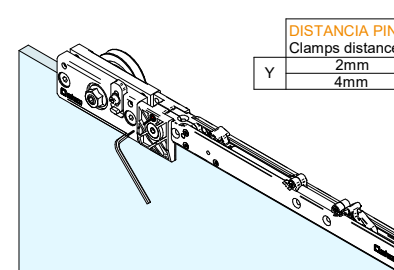

DISTANCIA PINZA	ESPOSOR CRISTAL
Clamps distance	Glass thickness
2mm	8mm
4mm	10mm

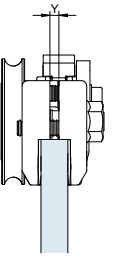

4 APRETAR LOS TORNILLOS / Tighten the screws

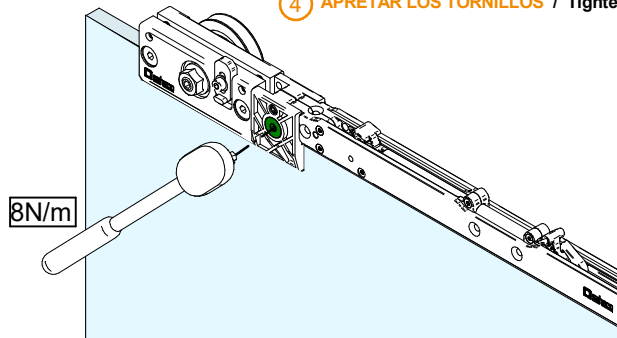

5 APRETAR LOS TORNILLOS / Tighten the screws

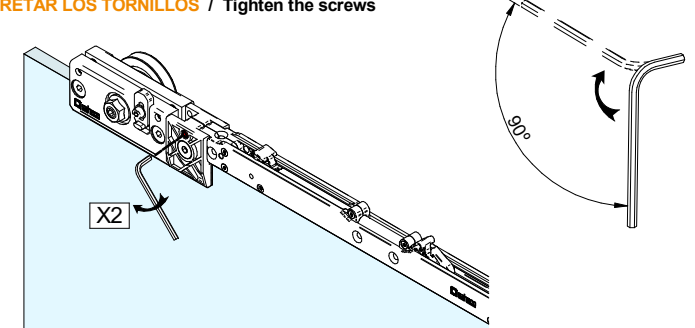

6 CARGAR EL SOFTBRAKE / Load the softbrake

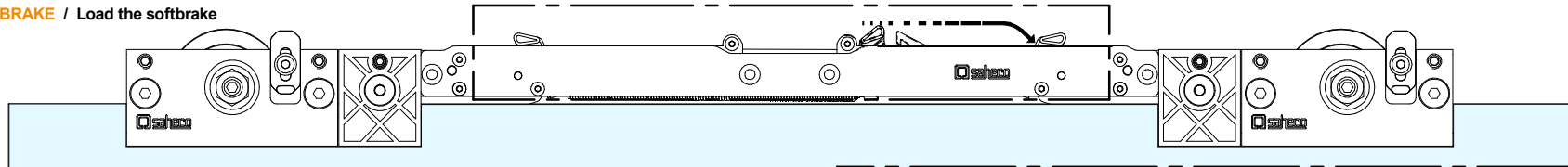

SOFTBRAKE DESCARGADO / Unloaded softbrake ❌

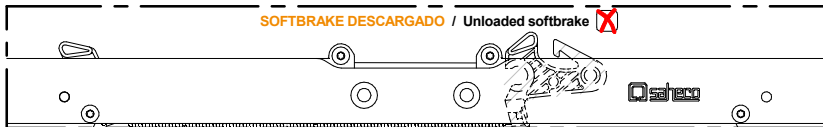

SOFTBRAKE CARGADO / Loaded softbrake ✅

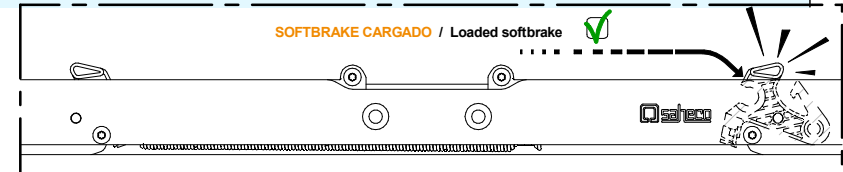

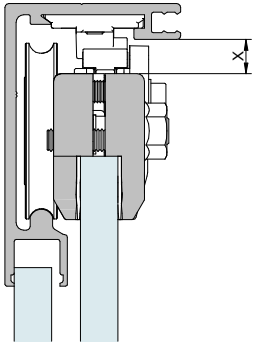

g^1		$X \geq 10,5\text{mm}$
g^2		$8,5\text{mm} < X < 10,5\text{mm}$
g^3		$X \leq 8,5\text{mm}$

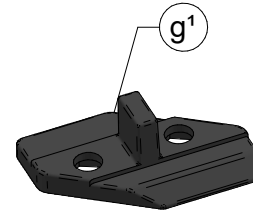

NEGRO / Black

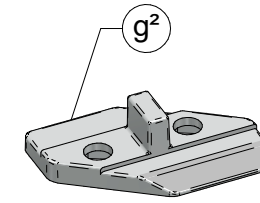

GRIS / Gray

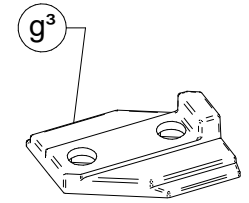

BLANCO / White

7 INSERTAR TUERCAS Y TORNILLOS / Insert nuts and screws

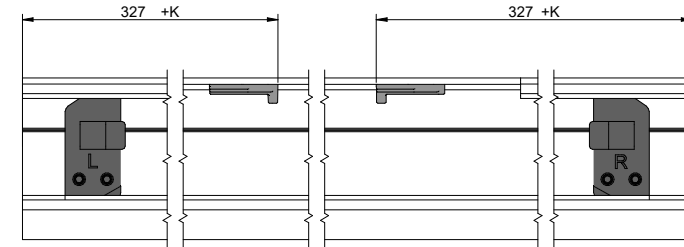
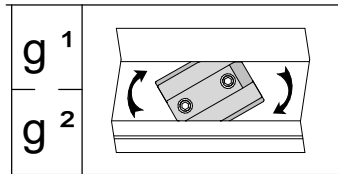
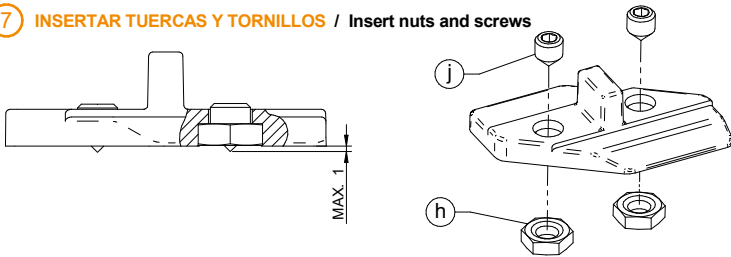

8 COLOCACIÓN DE LOS ACTIVADORES / Placing activators

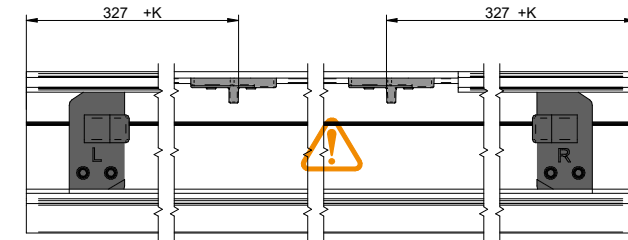
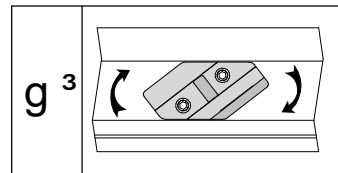

9 APRETAR LOS TORNILLOS / Strengthen the screws

